

■ **Roofing Panels**

Color Chart • Eagle Rib • High Rib/PBR • 5V Crimp • Steel Lock • Corrugated • Century Lock • Lock Seam

■ **Trim**

Exposed Fastener • Commercial • Standing Seam • Special Flashing

■ **Roofing Accessories**

Fasteners • Pipe Flashing • Closures • Sealants • Skylights • Ridge Vents

■ **Doors**

Personnel • Rollup

■ **Carport Components**

Galvanized Tube • Brackets

■ **Steel Buildings**

Buildings • Steel Building Components

■ **Pole Barns**

Gable or Lean-to

■ **Barn Components**

Cupolas • Weathervanes • Sliding Door Components • Sliding Door Automation • Stall Accessories

■ **Wall Fans**

Industrial • Commercial • Shutters

■ **Insulation**

Roll • Tape • Underlayment

■ **Metal Studs**

Stud • Track • Hat Channel

■ **Concrete Form Deck**

1½" B Deck

■ **Structurals**

Angle • Channel • Rebar • Bar Sheet • Pipe • Beams

■ **Expanded Metal**

Expanded Metal • Bar Grating

■ **Hand Tools**

Drip Tool • Shears • Snips • Seamers • Riveters • Hole Cutters

Roofing Panels

Color Chart

Eagle Rib

High Rib/PBR

5V Crimp

Steel Lock

Corrugated

Century Lock

Lock Seam

Alabama Steel Supply, Inc.

A Century of Evolving Steel Related Businesses

334.834.1505 phone | 334.834.7777 fax

www.alabamasteel.com

Eagle Rib

Roofing Panels

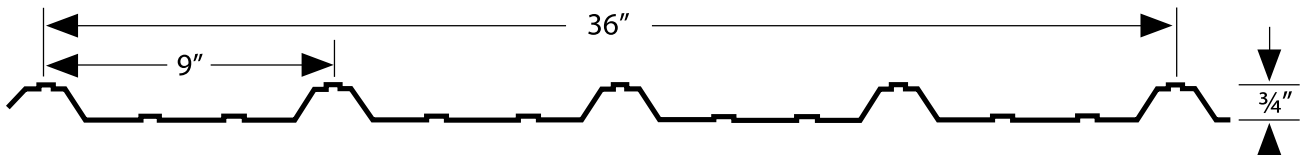

- Coverage Width = 36"
- Eagle Rib panel is a through-fastened panel.
- Gauges: 26 or 29 gauge available



Item ID	Description	Gauge	Finish
PE29	3' Panel	29	Paint/Galvalume
PE26	3' Panel	26	Paint/Galvalume

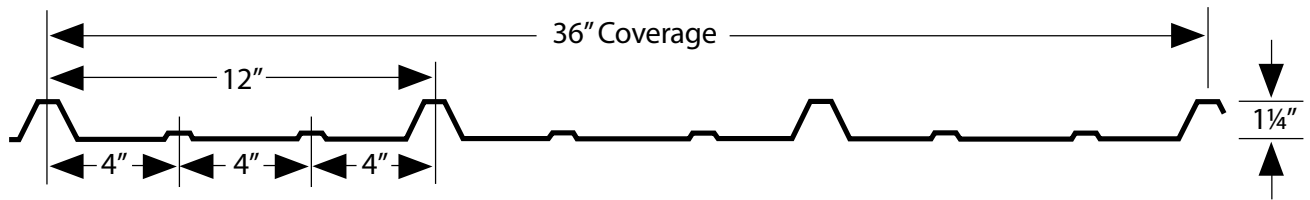

- Coverage Width = 36"
- PBR panel is a through-fastened panel.
- PBR is a structural roof & wall panel. This can be installed directly over purlins or joists.
- Gauge: 26 gauge (standard), 24 gauge available
- Coatings: Siliconized Polyester Paint or Acrylic Coated Bare.
- Reverse Rolled is an option for this panel to give an architectural look for a wall panel.



Item ID	Description	Gauge	Finish
PH26	3' Panel	26	Paint/Galvalume
PH24	3' Panel	24	Galvalume

5V Crimp

Roofing Panels

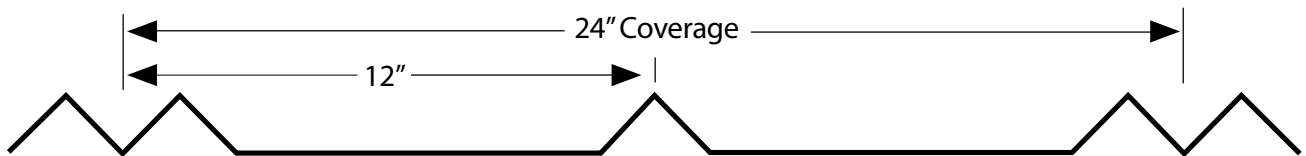

- Coverage Width = 24"
- Through-fastened panel
- Gauges: 26 or 29 gauge available

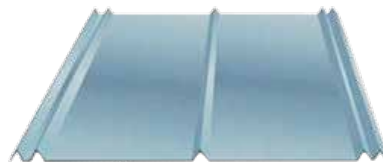

Item ID	Description	Gauge	Finish
PV29	2' Panel	29	Galvanized/Galvalume
PV26	2' Panel	26	Galvalume

Steel Lock

Roofing Panels

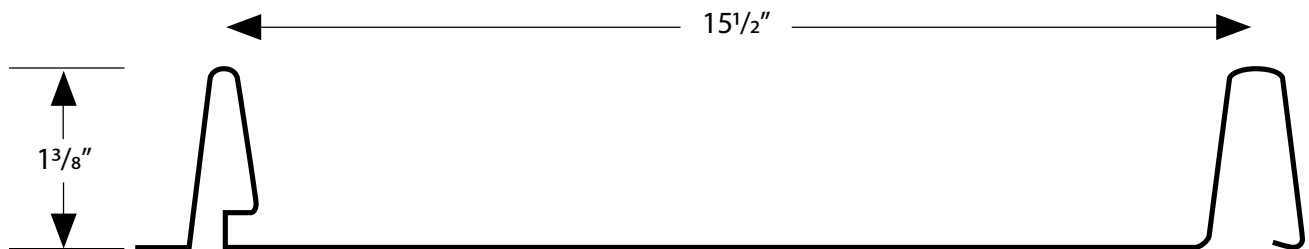

- Coverage Width = 15 1/2"
- Concealed fastener
- Gauges: 26 gauge available



Item ID	Description	Gauge	Finish
PSL26	15 1/2" Coverage	26	Paint/Galvalume

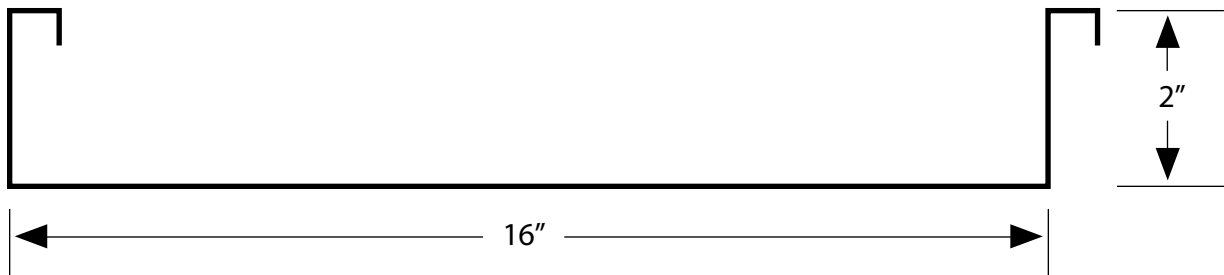

- Coverage Width = 16"
- Concealed fastener
- Gauges: 24 gauge available
- Coatings: Paint or Galvalume
- Mechanically Seamed

Item ID	Description	Gauge	Finish
PCL24	16" Coverage	24	Paint/Galvalume

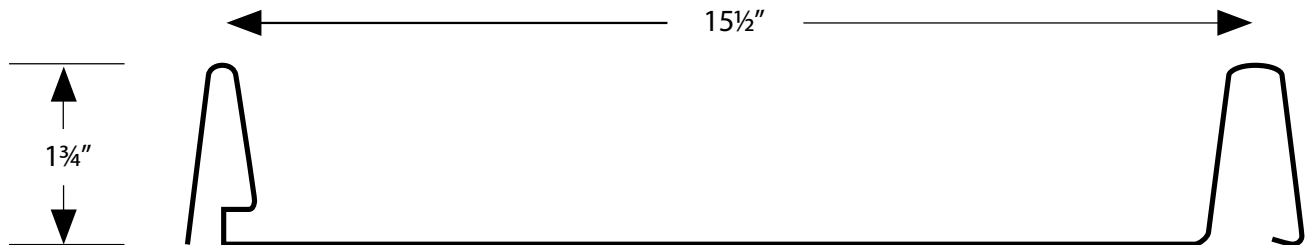

- Coverage Width = 16"
- Concealed fastener
- Gauges: 26 or 24 gauge available

Item ID	Description	Gauge	Finish
PLS26	16" Coverage	26	Paint/Galvalume
PLS24	16" Coverage	24	Paint/Galvalume

1 1/4" Corrugated

Roofing Panels

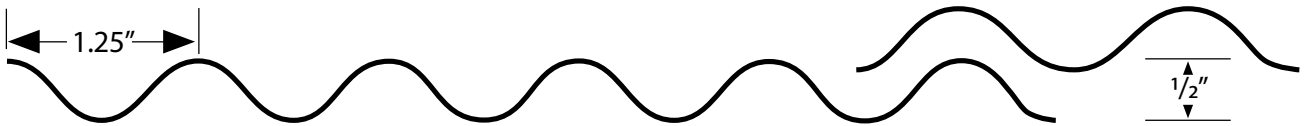

- Coverage Width = 2'
- Through-fastened panel
- Gauge: 26 or 29 gauge available
- Coatings: Galvalume or Galvanized
- 12' Max. Length



Item ID	Description	Gauge	Finish
PC29	2' Panel	29	Galvanized/Galvalume
PC26	2' Panel	26	Galvalume

2 1/2" Corrugated

Roofing Panels

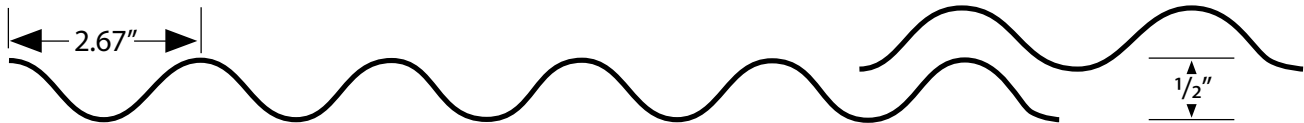

- Coverage Width = 2' or 3' (please inquire)
- Through-fastened panel
- Gauge: 26 or 29 gauge available
- Coatings: Siliconized Polyester Paint or Acrylic Coated Bare
- 12' Max. Length



Item ID	Description	Gauge	Finish
PC29	3' Panel	29	Paint/Galvanized/Galvalume
PC26	3' Panel	26	Paint/Galvalume
PC29	2' Panel	29	Galvanized/Galvalume
PC26	2' Panel	26	Galvalume

Trim

Exposed Fastener

Commercial Gutter & Rake

Standing Seam

Special Flashing

Alabama Steel Supply, Inc.

A Century of Evolving Steel Related Businesses

334.834.1505 phone | 334.834.7777 fax

www.alabamasteel.com

Exposed Fastener

Trim

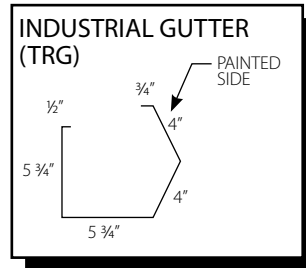
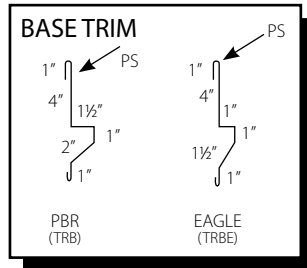
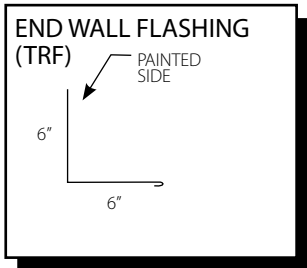
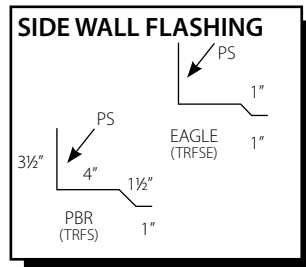
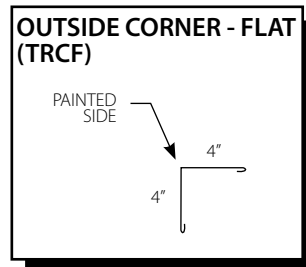
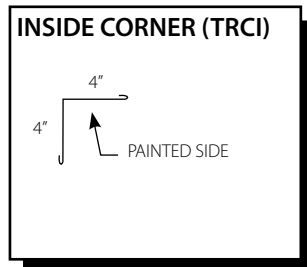
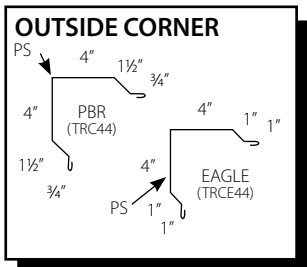
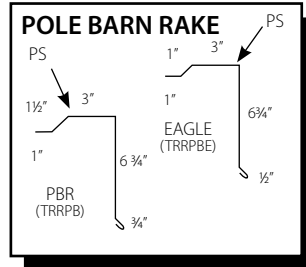
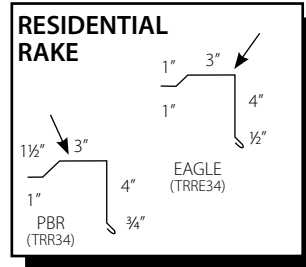
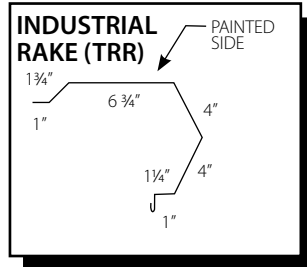
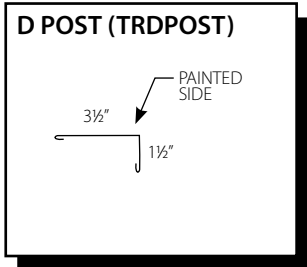
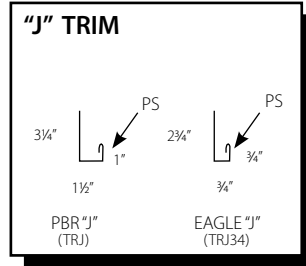
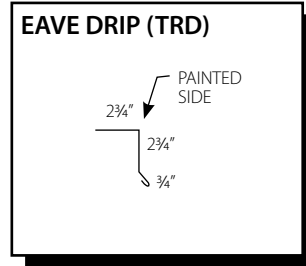
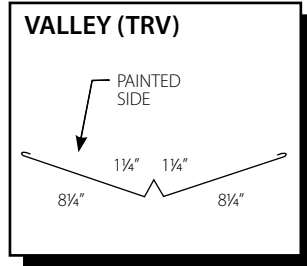
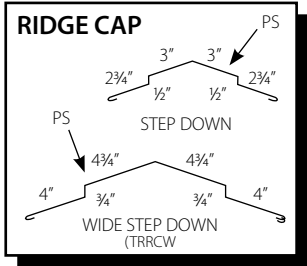

- STANDARD TRIM LENGTH: 10'-3"
- CUSTOM TRIM AVAILABLE WITH DRAWING
- (PS) DENOTES PAINTED SIDE

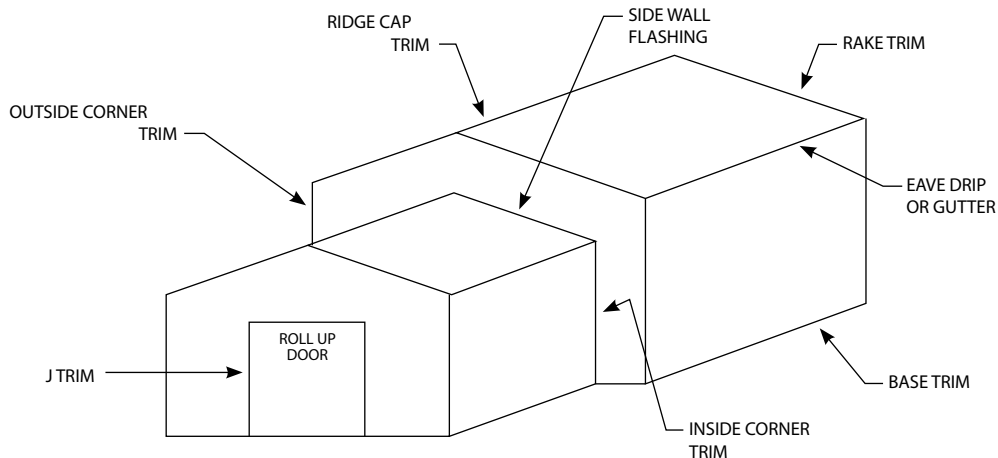

<p>Industrial Rake</p> <p>TRR</p>	<p>Industrial Gutter</p> <p>TRG</p>	<p>Gutter End Cap</p> <p>TREC</p>
<p>Rake End Cap</p> <p>TREC</p>	<p>One Piece Downspout & Elbow</p> <p>TRD</p>	<p>Corner Box</p> <p>TRCB</p>
<p>Downspout (Straight)</p> <p>TRDS</p>	<p>Downspout Elbow (W/45° Elbow)</p> <p>TRE</p>	<p>Gutter Strap</p> <p>TRHC</p>
<p>Downspout Strap</p> <p>TRDSSTR</p>		

EXTENDED DRIP

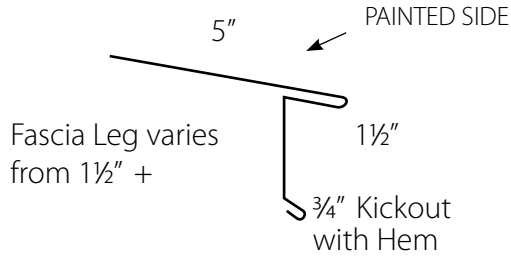

BOX RAKE

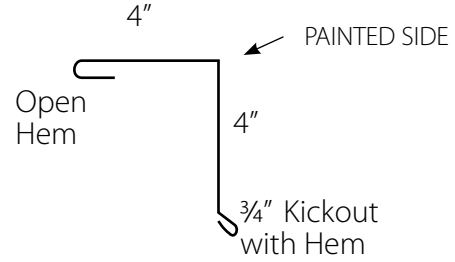

ZEE (FOR RIDGE, RAKE)

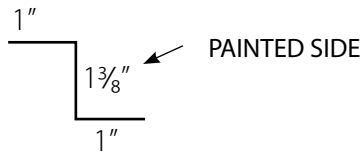

RIDGE/HIP

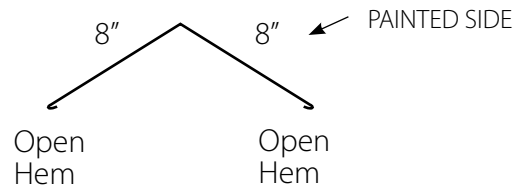

VALLEY WITH RAIN DIVERTER

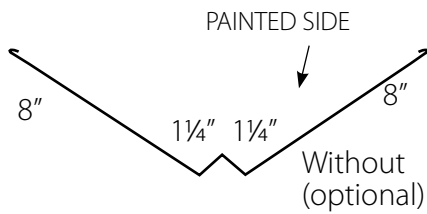

OFFSET CLEAT

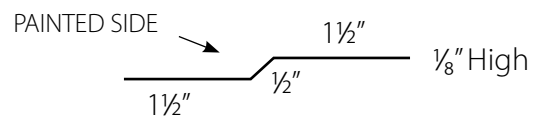

RAKE CLEAT

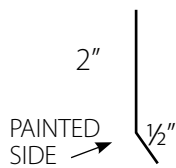

SIDEWALL TRIM

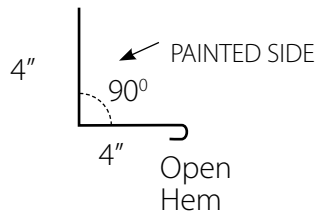

TRANSITION TRIM

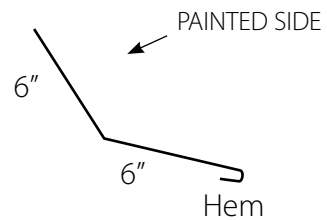

HOW TO ORDER SPECIAL FLASHING

NOTE:

1. Always dimension each segment
2. Always put in degrees of each angle
3. Always use degrees on inside angle from line to line (never use angle to a non-existing line).
4. Always show where color goes on each piece.
5. Calculate girth (flat width).

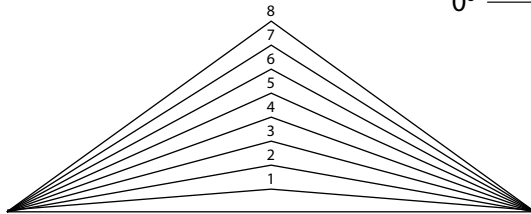
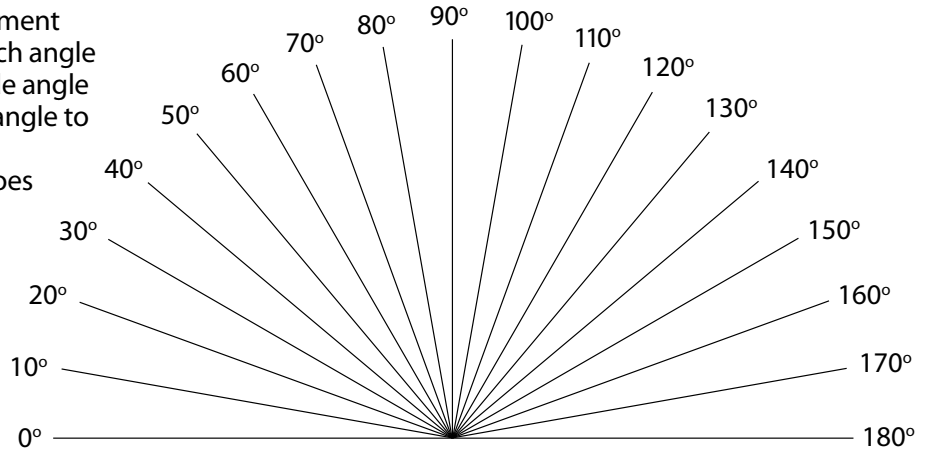

- 1:12 = 170°
- 2:12 = 161°
- 3:12 = 152°
- 4:12 = 143°
- 5:12 = 135°
- 6:12 = 127°
- 7:12 = 120°
- 8:12 = 113°

- 128° = 8:12
- 123° = 7:12
- 119° = 6:12
- 113° = 5:12
- 109° = 4:12
- 104° = 3:12
- 100° = 2:12
- 95° = 1:12
- 90° = FLAT

EAVE ANGLE

ANGLE CHART FOR HIP, VALLEY, RIDGE, GUTTER AND PITCH BREAK TRIM

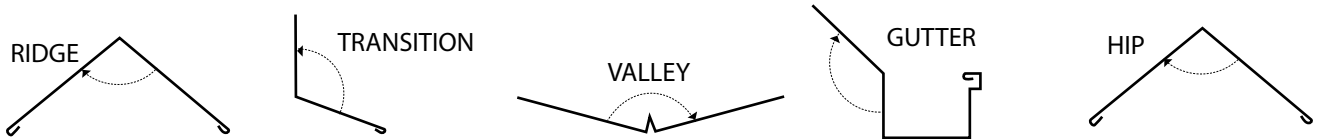

	ROOF SLOPE											
	1:12	2:12	3:12	4:12	5:12	6:12	7:12	8:12	9:12	10:12	11:12	12:12
HIP AND VALLEY	173°	166°	160°	154°	148°	143°	138°	133°	129°	126°	123°	120°
RIDGE	170°	161°	152°	143°	135°	127°	120°	113°	106°	100°	95°	90°
GUTTER AND PITCH BREAK	94°	99°	104°	108°	112°	116°	120°	123°	126°	129°	132°	135°

Roofing Accessories

Wood Fasteners

- Wood Fasteners with Sealing Washers
- Stainless Steel Wood Fasteners
- Long-Life Zinc Aluminum Cast Fasteners

Self-Drill Fasteners

- Self-Drill Fasteners with Sealing Washers
- Long-Life Self-Drill Fasteners
- Unwashed Plated Self-Drill Fasteners
- Clip Screws
- Self-Drill Fasteners - Heavy Gauge

Pipe Flashing

- Standard
- High Temperature Silicone
- Retro-Fit
- Universal

Closure Strips

- 5-V
- Eagle Rib
- R Panel
- Uni-Vent
- Uni-Seal

Sealants

- Butyl Tape
- Tube Caulk
- Gutter Seal
- Liquid Caulk

Skylights

- Eagle Rib Polycarbonate
- High Rib/PBR Fiberglass

Ridge Vents

- RV25
- RV35
- RV100

Alabama Steel Supply, Inc.

A Century of Evolving Steel Related Businesses

334.834.1505 phone | 334.834.7777 fax
www.alabamasteel.com

WOOD FASTENERS with Sealing Washers



ID	Description	Head Style	Drill Point	Bag Quantity	Weight Per 1000 pieces
SW1	10 x 1"	¼" HWH	S/P	250	8.0
SW112	10 x 1½"	¼" HWH	S/P	250	10.1
SW2	10 x 2"	¼" HWH	S/P	250	12.2
SW212	10 x 2½"	¼" HWH	S/P	250	15.4
SW3	10 x 3"	¼" HWH	S/P	250	17.2

Stainless Steel Wood Fasteners

ID	Description	Head Style	Drill Point	Bag Quantity	Weight Per 1000 pieces
SW112SS	10 x 1½"	¼" HWH	S/P	250	7.9



Long-Life Zinc Aluminum Cast

ID	Description	Head Style	Drill Point	Bag Quantity	Weight Per 1000 pieces
SW112ZAC	14-10 x 1½"	HWH	A	250	22.6

Note: Dimension lumber & plywood used to determine data shown is typical of materials used in post framed construction. Variations in density, grain structure or moisture content can cause some variations from values translated. The data was generated in a Seattle laboratory and are expressed in pounds ultimate. An appropriate factor of safety must be applied to obtain allowable values for design.

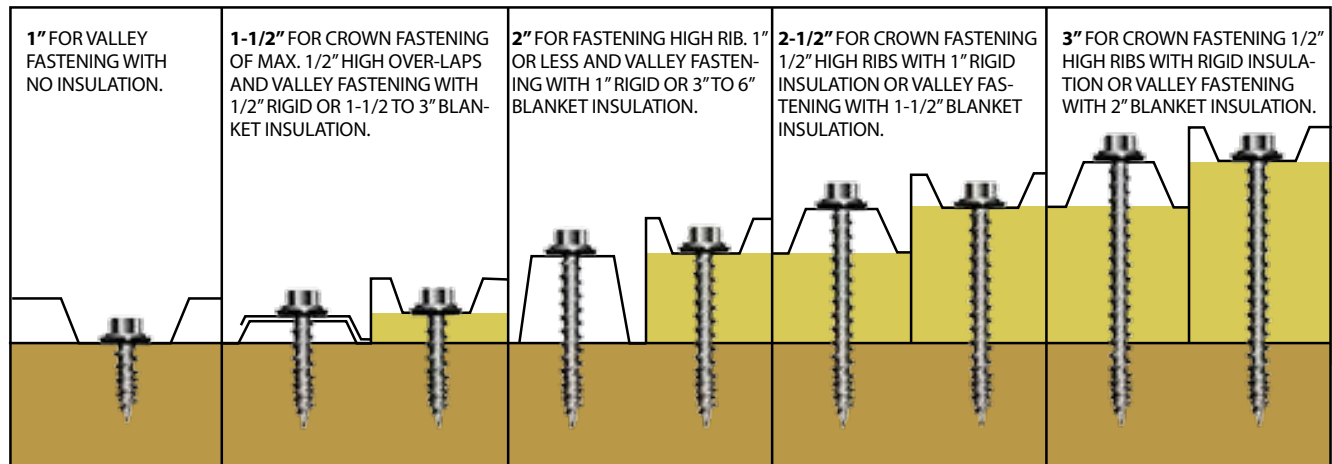

The above fastening suggestions are for fastening into 2 x dimensions using 1/2" high rib panels. For rigid insulation applications, 1-1/2" minimum penetration is desirable. Rib heights greater than 1" will require appropriate increase in fastener length to achieve minimum 1" penetration into substrate. For plywood substrates allow 1" penetration length to assure full diameter thread engagement in plywood.

Self-Drill Fasteners w/Sealing Washers

Hex Washer Head



ID	Description	Head Style	Drill Point	Bag Quantity	Weight Per 1000 pieces
SS	1/4-14 x 7/8" LAP	5/16" HWH	#1	250	15.1
SD114	12-14 x 1 1/4"	5/16" HWH	#2	250	15.1
SD212	12-14 x 2 1/2"	5/16" HWH	#3	250	24.8

Long-Life Self-Drill Fasteners

Long-Life Zinc Aluminum Cast



ID	Description	Head Style	Drill Point	Bag Quantity	Weight Per 1000 pieces
SD114	12 x 1 1/4"	HWH	#2	250	20.3
SS	14 x 7/8"	HWH	#1	250	18.0

Unwashed Plated Self-Drill Fasteners

Hex Washer Head (HWH)

Phillips Pan Head (PP) Self-Drill Fasteners - no washer



ID	Description	Head Style	Drill Point	Bag Quantity	Weight Per 1000 pieces
SD34Z2	12 x 3/4"	HWH	#3	250	8.4

Clip Screws

Clip Screw Fasteners



ID	Description	Head Style	Drill Point	Bag Quantity	Weight Per 1000 pieces
SDPANCAKE	10 x 1"	Ph. Pancake	Self-Drill	250	7.1
SWPANCAKESQ	10 x 1"	Ph. Pancake	Type "A"	250	7.0

Self-Drill Fasteners - Heavy Gauge

Specialty Self-Drill



ID	Description	Head Style	Drill Point	Bag Quantity	Weight Per 1000 pieces
Drills up to 1/2" Steel SD114ZBAD	12-24 x 1 1/4"	HWH	MAX H/D	250	12.6

Standard, High
Temp, Retro

Pipe Flashing

STANDARD - Available in Round Base



ID	Description	Pipe Size	Color	Carton Quantity	Weight Per Carton
BJPF3	#3	1/4 - 4"	Gray	15	7.5
BJPF4	#4	3 - 6"	Gray	10	8.0
BJPF5	#5	4 - 7"	Gray	10	9.5
BJPF6	#6	5 - 9"	Gray	10	12.0
BJPF7	#7	6 - 11"	Gray	10	15.5
BJPF8	#8	7 - 13"	Gray	5	12.8
BJPF9	#9	10 - 18"	Gray	5	19.3

HIGH TEMPERATURE Silicone



ID	Description	Pipe Size	Color	Carton Quantity	Weight Per Carton
BJPFHT3	#3	1/4 - 4"	Black	15	7.5
BJPFHT4	#4	3 - 6"	Black	10	8.0
BJPFHT5	#5	4 - 7"	Black	10	9.5
BJPFHT6	#6	5 - 9"	Black	10	12.0
BJPFHT7	#7	6 - 11"	Black	10	15.5
BJPFHT8	#8	7 - 13"	Black	5	12.8
BJPFHT9	#9	10 - 18"	Black	5	19.3

RETRO-FIT



ID	Description	Pipe Size	Color	Carton Quantity	Weight Per Carton
BJPF801	#1	1/2 - 4"	Gray	5	4.3
BJPF802	#2	4" - 9 1/4"	Gray	5	6.4

Universal Flashing

WAKAFLEX®



ID	Color	Roll Size	Roll Weight	Carton Quantity
BMWAKA11	Black	11" x 33'	22 lbs.	2 Rolls



Step One Trim
Trim opening to 20% smaller than pipe diameter.



Step Two Slide
Slide down over pipe.



Step Three Seal
Apply urethane/silicone sealant between ROOFJACK and roofing.



Step Four Form
Press, bending flashing to fit irregularities. Use large slot screwdriver to press into tight angles.



Step Five Fasten
Use fasteners to finish sealing.

5V, Eagle, PBR, UNI

Closures Strips



ID	Description	Height	Length	Pieces Per Carton
CS5VI	5-V Crimp Inside	½"	24"	100
CS5VO	5-V Crimp Outside	½"	24"	100



ID	Description	Height	Length	Pieces Per Carton
CSIR	Eagle Rib Inside	¾"	36"	100
CSIRI	Eagle Rib Outside	¾"	36"	100



ID	Description	Height	Length	Pieces Per Carton
CSHI	R Panel Inside	1¼"	36"	100
CSHO	R Panel Outside	1¼"	36"	100



Uni-Vent

ID	Description	Length
CSUV112	Vented Ridge Closure	20'



Uni-Seal

ID	Description	Length
CSHU112	Valley & Hip Closure	20'



Butyl Tape



ID	Description	Carton Quantity
BM	3/32" x 3/8" x 45'	48
BM1	3/32" x 1" x 50'	10
BM2	3/32" x 2" x 30'	8

Tube Caulk



ID	Description	Color	Size
CAGC	Tripolymer Sealant	Clear	10.3 oz. Tube



Gutter Seal

ID	Description	Color	Size
CAGGS	Tripolymer Gutter and Narrow Seam Sealant	Clear	5 oz. Tube

Liquid Caulk



ID	Description	Color	Size
CAGGQT	Tripolymer Brushable Repair Coating	Clear	1 Quart Can
CAGG	Tripolymer Brushable Repair Coating	Clear	1 Gallon Can



Typical Applications

- Skylights for corrugated metal roofs
- Sidelights
- Roofing

ID	Description	Color	Size
SLEP	Eagle Rib Polycarbonate	Opal	3'x 11'
SLEPC	Eagle Rib Polycarbonate	Clear	3'x 11'
SLH	High Rib/PBR Fiberglass	Translucent	3'x 11'



RV35, RV25, RV100

Ridge Vents

RV35 & RV35F

- 3½" Throat Ridg-Vent® with metal diverter or optional clear fiberglass for a vent and a skylight all in one.
- 10' Long
- 36 sq. inches of free area per linear foot (2.5 sq. ft./vent)
- Rises just 4½" above peak
- Over 25 colors available
- No up-charge for fiberglass

Features:

- All Ridg-Vents® are notched to a 4/12 roof pitch at the factory
- Our patented "Klix-on" flashing snaps in place without tools or fasteners
- Your crews install our products faster



RV25

- 10' Long
- 30 sq. inches of free area per linear foot (2.1 sq. ft./vent)
- Rises just 3" above peak
- Over 25 colors available
- Never an up charge for special colors



RV100

- 10' Long
- 15 sq. inches of free area per linear foot (1.04 sq. ft./vent)
- Rises just 2¾" above peak
- Over 25 colors available
- 25% more air flow than before
- Adaptable on the job site up to a 12/12 roof pitch

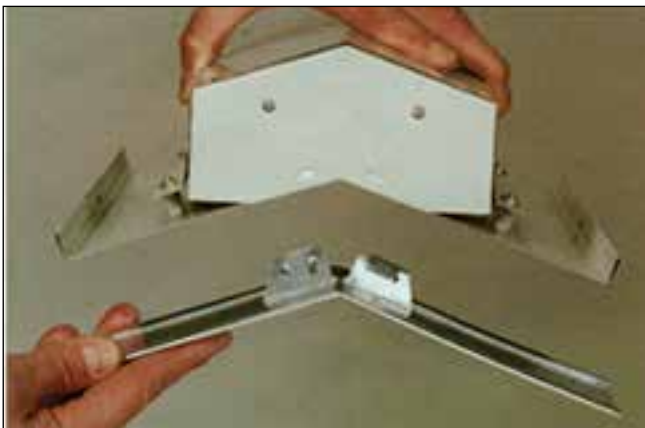

Doors

Personnel Doors

- 36" Steel Doors
- 48" Steel Doors
- 72" Double Doors
- 36" & 48" Aluminum Doors

Rollup Doors

- Mini Doors
- Series 1000 Roll-Up Doors
- Commercial Roll-up Doors

Alabama Steel Supply, Inc.

A Century of Evolving Steel Related Businesses

334.834.1505 phone | 334.834.7777 fax
www.alabamasteel.com



36" Steel Doors

ID	Description	Type	Color	Frames
DOP3W	3.0 x 7.0	Solid	White	4" or 8"
DOP3B	3.0 x 7.0	Solid	Bronze	4" or 8"
DOP3WHG	3.0 x 7.0	Half Glass	White	4" or 8"
DOP307BWG	3.0 x 7.0	Half Glass	Bronze	4" or 8"



48" Steel Doors

ID	Description	Type	Color	Frames
DOP4W	4.0 x 7.0	Solid	White	4" or 8"
DOP4B	4.0 x 7.0	Solid	Bronze	4" or 8"
DOP4BHG	4.0 x 7.0	Half Glass	Bronze	4" or 8"
	4.0 x 7.0	Half Glass	White	4" or 8"

72" Steel Double Doors

ID	Description	Type	Color	Frames
DOP4W	6.0 x 7.0	Solid or	White	4" or 8"
		Half Glass		



36" & 48" Aluminum Doors

ID	Description	Type
DOP3680	3.0 x 6'8"	Solid includes aluminum frame
DOP4080	4.0 x 6'8"	Solid includes aluminum frame

Roll-Up Doors

Doors



Mini Doors

ID	Width	Height	Color	Chain Hoist
DORU87	8'	7'	White	No
DORU97	9'	7'	White	No



Series 1000

ID	Width	Height	Color	Chain Hoist
DORU1010S1	10'	10'	White	Yes



Commercial

ID	Width	Height	Color	Chain Hoist
DORU1010	10'	10'	White	Optional
DORU1212	12'	12'	White	Yes
DORU1414	14'	14'	White	Yes

**Other standard sizes available as well as custom sizes available upon request.*

***Other standard colors available upon request.*

**** Electric operators available upon request.*

Carport Components

Galvanized Tube
Galvanized Carport Brackets
Hat Channel & Girts

Alabama Steel Supply, Inc.

A Century of Evolving Steel Related Businesses

334.834.1505 phone | 334.834.7777 fax
www.alabamasteel.com



Galvanized Tube

Item ID	Description	Length
CARTU11211215G	1½" x 1½" x 14 ga.	24'
CARTU2215G	2" x 2" x 15 ga.	24'
CARTU21221215G	2½" x 2½" x 15 ga.	20', 24'
CARTU3215G	3" x 2" x 15 ga.	16', 20', 24'

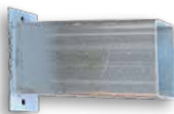

Galvanized Carport Brackets

Item ID	Description	Slope
CAR21224Center	24" Center Bracket	4:12
CAR23430Center	30" Center Bracket	4:12
CAR2126Corner	2¼" x 6" Corner Bracket	4:12
CAR2129Corner	2¼" x 9" Corner Bracket	4:12
CAR2149Corner	2¼" x 9" Corner Bracket	1:12
CAR14GPost	2 x 2 x 2 x 14 ga. Post Angle	
CAR10GPost	3 x 3 x 2½" x 10 ga. Post Angle	
CAR24Flat	2" x 4" Flat Bracket	
CARLT	Lean-To Bracket	1:12

Hat Channels & Girts

Item ID	Description	Height	Thickness	Length
HGC	1½" Galvanized Hat Channel	1½"	20 ga.	20'
HG	1½" Galvanized Hat Girt	1½"	20 ga.	20', 24'
HG18	1½" Galvanized Hat Girt	1½"	18 ga.	20', 24'

Steel Buildings

Pre-Engineered Buildings

Steel Building Components

- Zees
- Cees
- Eave Struts
- Base Angle

Alabama Steel Supply, Inc.

A Century of Evolving Steel Related Businesses

334.834.1505 phone | 334.834.7777 fax

www.alabamasteel.com

Pre-Engineered Buildings

Steel Buildings

Whether you need a steel building for a commercial office building, strip mall, retail space, store front, warehouse space or residential needs, we have the right building system for you. Alabama Steel Supply can custom design a pre-engineered metal building for virtually any application.

- Wide variety of styles to fit any budget and application
- Knowledgeable sales staff to assist you through the entire process
- No building is too big or small



Zee Purlin



Item ID	Description	Thickness	Finish	Length
ZP416	4" Zee Purlin	16 ga.	Red Oxide	22'
ZP414	4" Zee Purlin	14 ga.	Red Oxide	22'
ZP616	6" Zee Purlin	16 ga.	Red Oxide	22'
ZP614	6" Zee Purlin	14 ga.	Red Oxide	22'
8ZP16	8" Zee Purlin	16 ga.	Red Oxide	22', 3.5", 27' 3.5"
8ZP14	8" Zee Purlin	14 ga.	Red Oxide	22' 3½", 27' 3½", 32' 3½"

Cee Purlin



Item ID	Description	Thickness	Finish	Length
CP416	4" Cee Purlin	16 ga.	Red Oxide	20'
CP414	4" Cee Purlin	14 ga.	Red Oxide	20'
CP616	6" Cee Purlin	16 ga.	Red Oxide	20'
CP614	6" Cee Purlin	14 ga.	Red Oxide	20'
CP816	8" Cee Purlin	16 ga.	Red Oxide	20'
CP816	8" Cee Purlin	14 ga.	Red Oxide	20', 25', 30'

Eave Struts



Item ID	Description	Thickness	Finish	Length
ES814112	8" Eave Strut 1:12	14 ga.	Red Oxide	20', 25'

** Inquire for other sizes and pitch.*

Base Angle



Item ID	Description	Thickness	Finish	Length
BA4214	4" x 2"	14 ga.	Red Oxide	20'

** Inquire for special gauges, lengths & finishes*

Pole Barns

Gable or Lean-to

Alabama Steel Supply, Inc.

A Century of Evolving Steel Related Businesses

334.834.1505 phone | 334.834.7777 fax

www.alabamasteel.com



The ideal storage solution for a new Garage, Storage Building, Equipment Building, Horse Barn, Hay Shed or Work Shop. Pre-fabricated steel trusses and simple post frame construction will allow you to complete your project for less without giving up the quality that you expect. Our Pole Barns are constructed using 6 x 6 posts, 2 x 6 purlins and 29 gauge Galvalume Eagle Rib roof and wall panels. They are available in standard widths of 16', 24', 30', 36', and 40'. They can also be special ordered in widths to fit your needs. With readily available materials and ease of construction your project can be completed quickly and you can enjoy the durability and beauty of your new Pole Barn. Ask your local dealer to help you design your Pole Barn solution.

- Our pole barns are built for strength and ease of installation!
- We combine wood and steel to create an economical and useful solution for your storage needs!
- Pole barn trusses can be used in a variety of different ways: Barn structures, agricultural buildings, home storage, and workshop buildings!

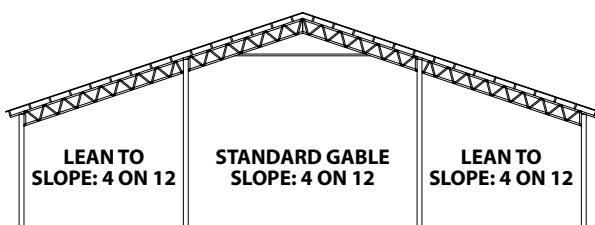
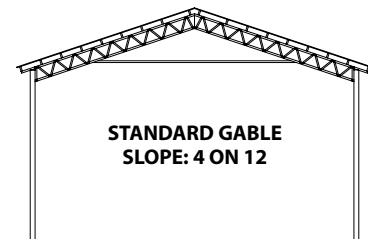

**STANDARD GABLE
SLOPE: 4 ON 12**

**LEAN TO
SLOPE: 4 ON 12**

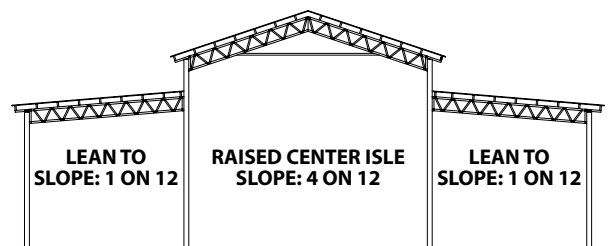

Choose Your Size & Style

Pole Barns

- ROOF ONLY BUILDINGS HAVE 12" OVERHANG.
- ENCLOSED BUILDINGS HAVE NO OVERHANG.
- GABLE ROOF SLOPE: 4 ON 12.
- LEAN TO'S: 1 ON 12 OR 4 ON 12.
- PURLIN CUPS ARE 24" O.C.
- DIMENSIONS WIDTH & LENGTH ARE OUT / OUT OF POSTS.
- SIDEWALL POST SPACING 10' OR 12'.

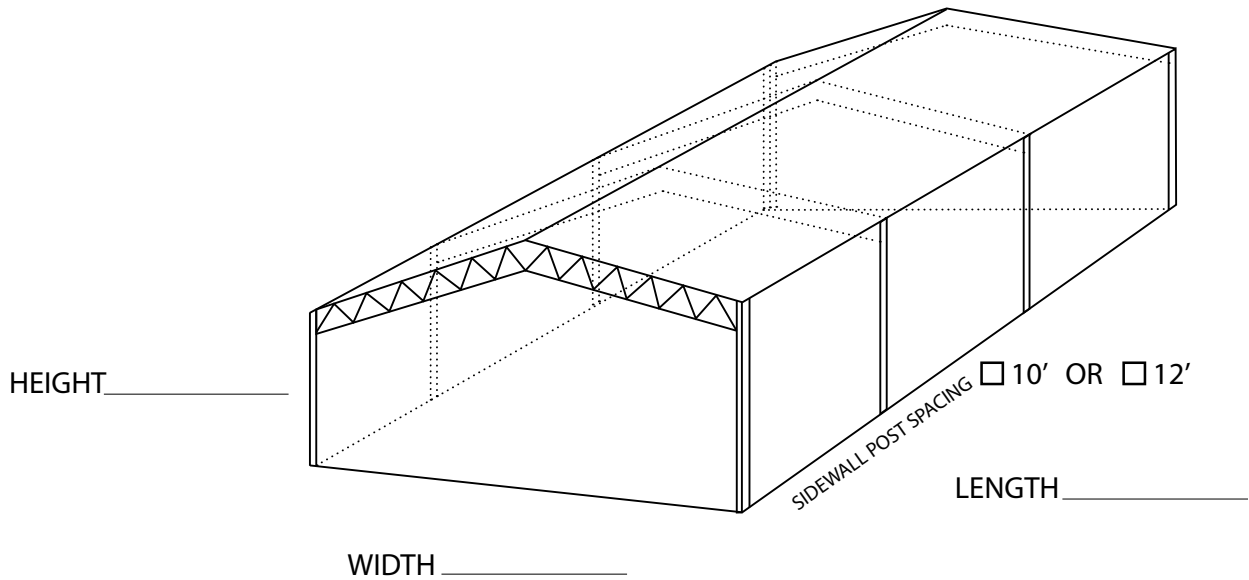

(SKETCH)

Barn Components

Cupolas

Weathervanes

Sliding Door Components

Door Automation

Horse Stall Doors

- Door with Yoke
- Door with Drop Front
- Standard Stall Door
- Latch Options and Hardware for Stall Doors
- Dutch Doors
- Bale Doors
- Arcadian Sliders

Horse Stall Grills

- Grill with 12 x 12 Feed Opening
- Standard Grill
- Swing Out Feed Door
- Burgundy Grill with 12 x 12 Feed Opening

Horse Stalls

Color Chart

Alabama Steel Supply, Inc.

A Century of Evolving Steel Related Businesses

334.834.1505 phone | 334.834.7777 fax

www.alabamasteel.com

Cupolas

Barn Components

We offer a large color palette to match metal sheeting.



24" with Windows and Premium Flashing

36" with Louvers and Premium Flashing



48" Octagon Cupola with Windows



Square Cupolas available in 24", 36", 48" & 66" or 48" Octagon

Prepainted 29 ga. construction. Available in over 100 standard colors plus Kynar. All metal edges are hemmed. No need to worry about red-rust. Bird screen included for mounting in curb. Roof and sides interlock for weather-tite connection. 24", 36" & 48" ship knocked-down; 66" & octagon ship assembled.



66" Cupola with Louvered Sides



Universal base adjustable on job from 1/12 up to 7/12 roof pitch. Available with flashing kit or power coat option.*

* Powder coat option available in 28 colors

Cupolas

Barn Components

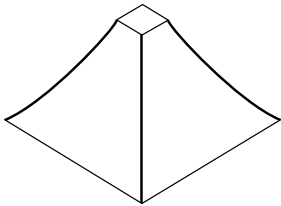

Model: C240/C360/C480/C660
 24" x 24", 36" x 36", 48" x 48", 66" x 66" Cupola Roof.
 Installs on top of the side sections.
 Ships knocked-down.

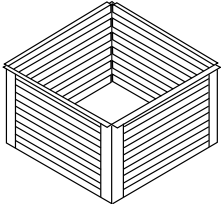

Model: C245/C365/C485/C665
 24" x 24", 36" x 36", 48" x 48", 66" x 66" Cupola Sides.
 Installs on top of any of the flashings.
 Ships knocked-down.

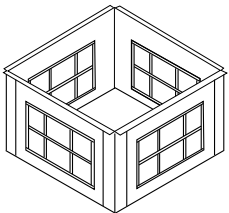

Model: C245W/C365W/C485W/C665W
 24" x 24", 36" x 36", 48" x 48", 66" x 66" Cupola Sides with Windows.
 Installs on top of any of the flashings. Ships knocked-down.

Grid Patterns: 24" = 2 x 2
 36" x 48" = 3 x 2
 66" = 2 x 3
 48" octagon = 2 x 4

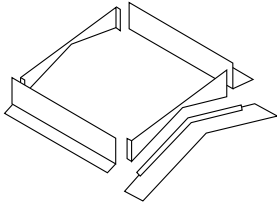

Model: C241P/C361P/C481
 6-piece Standard Flashing Kit.
 Specific roof pitch must be ordered and wood support curb is field fabricated.
 Ships knocked-down.

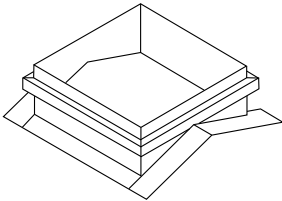

Model: C241P/C361P/C481P/C661P
 10-piece Premium Flashing Kit.
 Specific roof pitch must be ordered and wood support curb is field fabricated.
 (Frame is 3 1/2" higher than standard). Ships knocked-down.

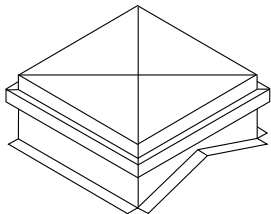

Model: C242/C362/C482 Universal Base
 Factory assembled base that requires no wood curb.
 Adapts to roof pitches from 1/12 up to 7/12. The same unit is used for vented and non-vented applications. Mounts on the top of steel roofing or on purlins. Both new construction and retrofits utilize the same base.

Available with either the universal flashing kit or powder coat* option.
 * powder coat option available in 28 colors

Base Size	24" x 24"	36" x 36"	48" x 48"	66" x 66"	48" Octagon
Total Height	37"	44"	59"	72"	77"
Building Width*	24' - 30'	36' - 40'	48' - 60'	User Defined	User Defined
Building Length*	24' Centers	36' Centers	48' Centers	User Defined	User Defined
Weathervane*	24" or 30"	30"	46"	46" or Larger	46" or Larger

* Recommended. Contact Alabama Steel Supply for details

Stock Weathervanes

24"



Country Doctor



Eagle



Horse



Rooster



Antique Auto



Country Doctor



Duck



Horse



Pig



Rooster

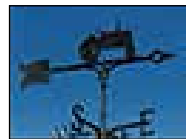

Tractor



Sailboat

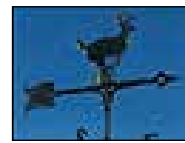

Buck



Cow

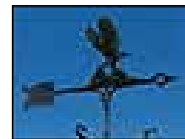

Eagle



Pheasant

46"

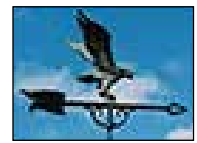

Eagle



Horse



Rooster

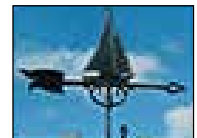

Sailboat

30" Non-Stock Weathervanes

Non-Stock weathervanes come in a standard black finish but are available in color (shown). Please contact us for details.



Airplane



Amish Buggy



Antique Auto



Blue Heron



Buck



Bull Rider



Butterfly



Cardinal



Cat



Chevy 1913



Country Doctor



Cow



Cowboy



Deer in Pines



Dove of Peace



Draft Horse



Duck



Eagle



Elk



Fire Wagon



Flamingo



Gargoyle



German Shepard



Golden Retriever



Golfer Lady



Golfer



Hansom Cab



Horse



Hummingbird



Lab



Lampighter



Liberty Flag



Lighthouse



Loon



Macaw



Mare & Colt



Moose



Motorcycle



Owl



Palm Trees



Pelican



Pheasant



Pig



Prospector



Rooster



Sailboat



Schooner



Spear



Squirrel & Pines



Town Crier



Tractor



Train



Trout

Sliding Door Components

Barn Components

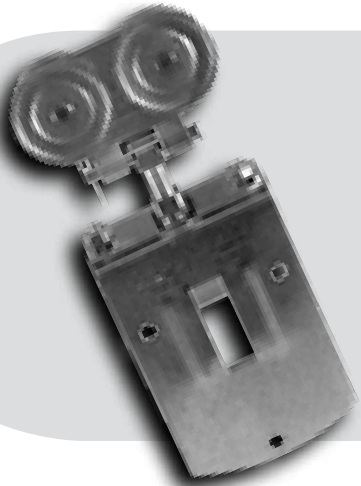

Square Track & Accessories
1½" Aluminum Rail Options
Sliding Door Accessories

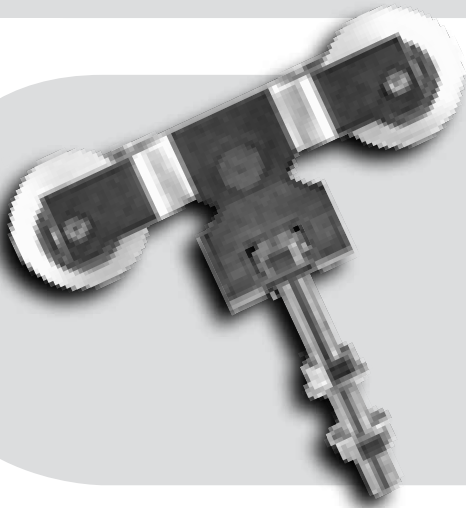
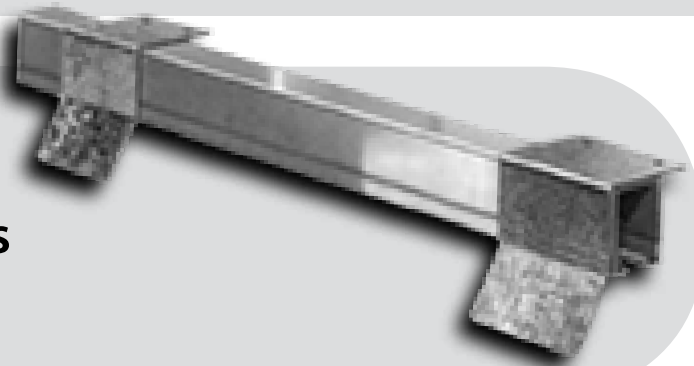

Round Track & Accessories
3½" Aluminum Rail Options
Steel Horizontals

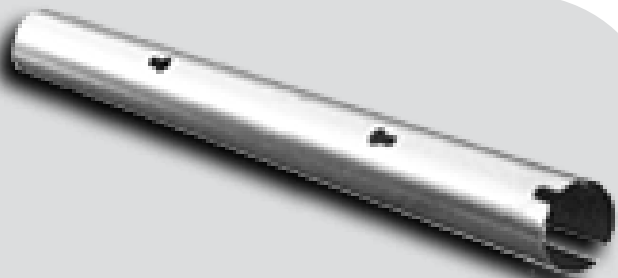

Door Automation

Barn Components

Sliding Door Automation

In a world where farmers embrace new technology to feed a rapidly growing population, convenience and efficiency are more important than ever. GPS, telematics, kinematics, RFIDS, soil and crop sensors, self-steering, high-flex tires and ISOBUS ready tractors are just a few examples of how technology has helped to advance modern farming practices. Until now, that technology advancement stopped at the machine shed door.

On a 30' wide split sliding door, you will walk 90' to unlatch, unchain, and open each panel. Then do it again in reverse to close them – after you've climbed into your tractor and driven it out, then climbed back down again and walked back into the building to secure it. It's easier just to leave the doors open until the end of the day and hope that no one wanders in or that a storm doesn't roll in and wreak havoc on your shed and its contents.

Finally, a system has been developed to address these issues. Sliding Door Automation is helping farmers, ranchers and builders design more functional buildings that are easier on the budget. For existing buildings, alleviate costly door replacement by automating existing sliding doors.



You have a remote for your garage door. Why not for your machine shed, horse barn, or shop doors?

Security | Safety | Convenience

This system was designed specifically for single and bi-parting sliding shed doors.

- Powerful motors with only 1 moving part
- Commercial strength
- Quiet operation
- Internal obstacle detection and photo cell safety sensors
- No loss in opening height. Minimal loss in opening width (as low as 3" - 4")
- No ongoing maintenance required
- Works on doors up to 42 feet
- Easy to install
- Works on existing doors



The Drive System consists of the industrial grade operator, safety features, header drive track, wall-mounted control station and remote controls. It works on both wood and metal framed buildings.



The direct drive system is inside the building out of the weather. The powerful motor runs smoothly with the door.



The Controller/Wall Station is now more powerful and features Plug'n Play connections.



The Clincher controls the back side of the door and snugs the closed doors against the building.



Secure the bottom of your door with either the Floor Track or the Floor Guides. These systems ensure that your closing doors always meet at the center. They also prevent the wind from blowing your doors into or away from the building. The Floor Track goes in the inside of the building between the jambs. The Floor Guides mount outside the building along the bottom of the door.

Stall Doors



Door with Yoke



Door with Drop Front



Standard Stall Door

Latch Options and Hardware for Stall Doors



Stall, Gate & Door Latch
Available in all powder coat colors



Track Package
Includes Track End Caps*, Stay Roller Bracket*,
Keepers* and Trolleys
*Color matched to stalls



**Outside view of recessed
push button latch**
Available in all powder coat colors



**Inside view of recessed
push button latch**



8" Color Matched Track
Available in face or top mount

Horse Stall Doors

Barn Components

Other Doors

Assembled or Knocked Down

Dutch Doors



Bale Doors



Window Bale

Bale Door

Arcadian Sliders



Arcadian Double Buck Slider

Arcadian Half Lite Slider



Stall Grills



**Grill with 12 x 12
Feed Opening**



Standard Grill



Swing Out Feed Door

14 Gauge Grills: One piece grills up to 144" long are available for stall fronts and partition walls. Grill-work is all galvaneal substrate for maximum protection. All welds are concealed to prevent rust. Fronts are available with standard grills, feed openings or swing out feed door options.



Burgundy Grills with 12 x 12 Feed Opening



Horse Stalls

Barn Components

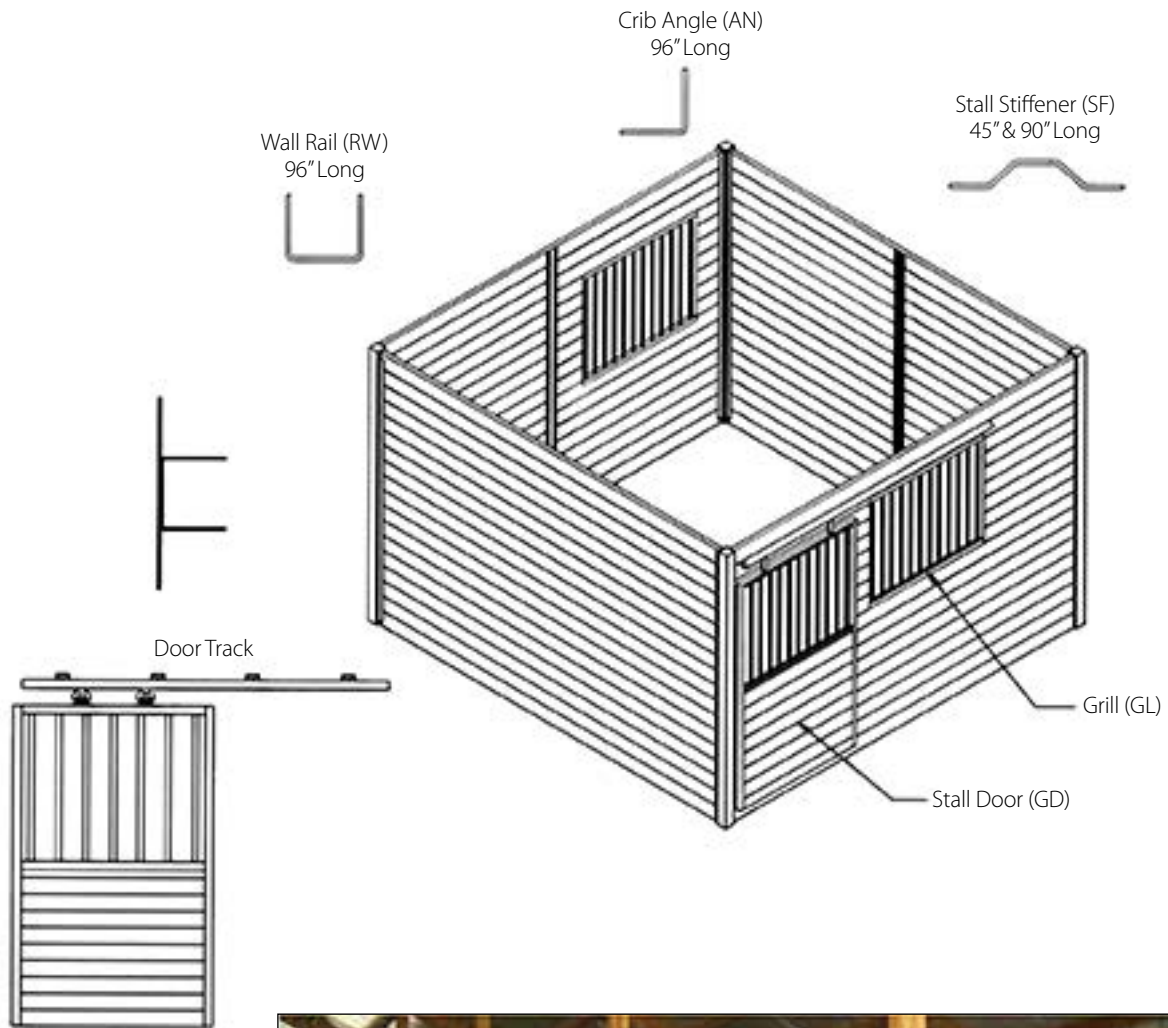

Color Chart

Barn Components



- Exact color match to most roll former's color.
- 14 gauge galvaneal substrate - the best material for powder coating horse stalls.
- Custom grills up to 144" long
- Subtly textured colors give the product a beautiful finish.

**Black Finish available in textured or non-textured*

***Mill Finish standard is non-textured*

			
700 Bone White	701 Earth Brown	702 Evergreen	704 Barn Red
			
705 *Black	706 Light Gray	707 Pebble Beige	708 Dark Brown
			
709 Light Blue	711 Clay	712 Rawhide	714 Dark Blue
			
718 Sandstone	720 Quaker Gray	723 Slate Blue	726 Pewter Gray
			
727 White	730 G. C. Gray	731 G. C. Red	734 Antique Brown
			
736 Burgundy	743 Forest Green	745 Ocean Blue	746 Bright Red
			
747 Zinc Gray	750 Ash Gray	760 **Mill	778 Patriot Red

Colors may vary slightly from what is shown

Wall Fans

Industrial Wall Fans

Commercial Wall Fans

Shutters

Alabama Steel Supply, Inc.

A Century of Evolving Steel Related Businesses

334.834.1505 phone | 334.834.7777 fax

www.alabamasteel.com



“VI” SERIES

Patented Industrial
For moving large volumes of air

- Standard units from 1/3 to 5 hp (4,100 to 43,100 cfm)
- Extra heavy duty components and frame with durable powder coat finish
- Unique fastening system for easy field adjustment

Triangle’s exclusive “X-Wing” Belt Tensioner

Incorporates the motor and bearing mounts along with a super efficient Belt Tensioner to enhance the life of the motor. It is standard equipment on the VI 2412 through the VI 4816. Fans with motors larger than 1 1/2 hp have the standard stationary motor and bearing mounts.



Patent #6, 190, 140

Model No.	Blade Diameter	Motor CFM	RPM	HP	Amps	Volts	Ship Wt. (lbs)	Overall Sq. Size	Depth
VI2412	24	4,100	705	1/3	6.5	115	101	30 3/4"	20"
VI3013	30	9,000	742	1/2	11.0	115	113	34 3/4"	20"
VI3014	30	10,000	732	3/4	13/6.5	115/230	117	34 3/4"	20"
VI3613	36	10,400	550	1/2	11	115	138	40 3/4"	20"
VI3614	36	11,100	540	3/4	13/6.5	115/230	146	40 3/4"	20"
VI3615	36	12,100	555	1	11/5.5	115/230	164	40 3/4"	20"
VI4213	42	13,000	500	1/2	11	115	151	46 3/4"	20"
VI4214	42	14,600	565	3/4	13/6.5	115/230	153	46 3/4"	20"
VI4215	42	15,900	475	1	11/5.5	115/230	164	46 3/4"	20"
VI4216	42	17,100	450	1 1/2	5.6/2.8	230/460	161	46 3/4"	20"
VI4814	48	18,900	455	3/4	13/6.5	115/230	187	52 3/4"	20"
VI4815	48	20,500	470	1	11/5.5	115/230	198	52 3/4"	20"
VI4816	48	20,800	480	1 1/2	5.6/2.8	230/460	200	52 3/4"	20"
VI4817	48	21,100	605	2	6.4/3.2	230/460	267	52 3/4"	24"
VI4818	48	23,700	610	3	8.4/4.2	230/460	291	52 3/4"	30"
VI5417	54	25,500	615	2	6.4/3.2	230/460	338	62 7/8"	30"
VI5418	54	30,100	620	3	8.4/4.2	230/460	343	62 7/8"	30"
VI5419	54	37,200	650	5	13.8/6.9	230/460	343	62 7/8"	30"
VI6017	60	30,200	611	2	6.4/3.2	230/460	410	68 7/8"	30"
VI6018	60	34,000	610	3	8.4/4.2	230/460	418	68 7/8"	30"
VI6019	60	43,100	650	5	13.8/6.9	230/460	422	68 7/8"	30"



"V" SERIES Commercial

- Units are available from 24" to 48" with 1/3 to 3/4 HP motors, delivering 3,900 to 18,200 CFM
- All welded construction with a durable powder coat finish
- A wide paddle, deep-pitch blade assembly delivers maximum performance with whisper-quiet operation
- Triangle's exclusive automatic belt tensioning system extends motor life and eliminates the need for belt adjusting



Model No.	Blade Diameter	Motor CFM	RPM	HP	Amps	Volts	Ship Wt. (lbs)	Overall Sq. Size	Mounting Depth
V 2412	24	3,900	550	1/3	6.5	115	50	30"	1 1/2"
V 3012	30	6,300	525	1/3	6.5	115	51	34"	1 1/2"
V3013	30	9,500	605	1/2	11	115	58	34"	2"
V3613	36	10,900	520	1/2	11	115	61	40"	2"
V4213	42	14,300	500	1/2	11	115	93	46"	2"
V4813	48	17,100	365	1/2	11	115	105	52"	2"
V4814	48	18,200	410	3/4	13/6.5	115/230	135	52"	2"

All Weather Hoods

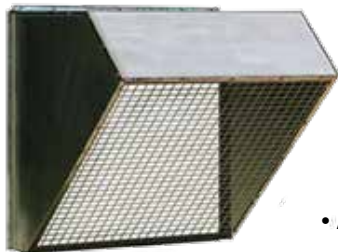

For VI, V and PFG Series Fans

- All Galvanized 18-gauge steel with 1" x 2" bird screens

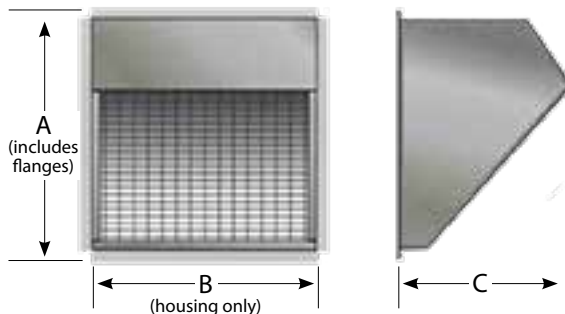

Model	For Fan Size	A sq. (inc. flanges)	B sq. (inc. flanges)	C
RH 24	24"	34 1/4"	31 3/4"	31"
RH 30	30"	37 1/4"	34 3/4"	33"
RH 36	36"	43 1/4"	40 3/4"	37"
RH 42	42"	49 1/4"	46 3/4"	41"
RH 48	48"	55 1/4"	52 3/4"	45"
RH 54	54"	65 1/4"	62 3/4"	52"
RH 60	60"	71 1/4"	68 3/4"	57"

FAN MODEL NUMBER EXPLANATION

MODEL NAME:	VI	48	1	5	HORSEPOWER:
	VI Series Industrial	Blade Diameter	Motor Speed		2 = 1/3 HP 6 = 1.5 HP
					3 = 1/2 HP 7 = 2 HP
					4 = 3/4 HP 8 = 3 HP
					5 = 1 HP 9 = 5 HP

Heavy Duty Industrial Automatic Wall Shutters



Shutters automatically open and close with fan operation. Available for 24" to 60" fans.

- Extruded aluminum mill finish blades for corrosion resistance
- Durable bronze bushings for smooth, maintenance free operation
- IWS 54" and 60" are double-paneled for added strength
- Optional electric motor operators are available for all sizes



Model No.	Fan Size		Outside Dimension	Inside Dimension	Depth	Ship Wt. (lbs)
IWS 24	24"		33 3/8" X 33 3/8"	31" X 31"	4"	26
IWS 30	30"		36 3/8" X 36 3/8"	34" X 34"	4"	29
*IWS 33	36"		39 3/8" X 39 3/8"	37" X 37"	4"	33
IWS 36	36"	24" thru 48" Single Panel	42 3/8" X 42 3/8"	40" X 40"	4"	37
*IWS 39	42"		45 3/8" X 45 3/8"	43" X 43"	4"	39
IWS 42	42"		48 3/8" X 48 3/8"	46" X 46"	4"	46
*IWS 45	48"		51 3/8" X 51 3/8"	49" X 49"	4"	43
IWS 48	48"		54 3/8" X 54 3/8"	52" X 52"	4"	55
IWS 54	54"	Double Panel	63 3/8" X 63 3/8"	61" X 61"	4.5"	48
IWS 60	60"		69 3/8" X 69 3/8"	67" X 67"	4.5"	56
IWS 3187	Shutter Operator w/linkage		IWS 24-48	Amps: .5/.25	Volts: 115/230	3
IWS 887	Shutter Operator w/linkage		IWS 54-60	Amps: .5/.25	Volts: 115/230	5

NOTE: To order as an INTAKE SHUTTER, put an "R" in front of the model number.

* Mounts to fan housing - consult factory.



V Series - 14" wide, 18 gauge, galvanized housing, with black powder coat finished guard.

Model	For Fan	Shipping Weight
VG 24	24"	43
VG 30	30"	50
VG 36	36"	58
VG 42	42"	65
VG 48	48"	73

Fan Guards

VI Series - Guard has a black powder coat finish.

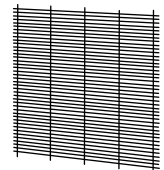

Model	For Fan	Shipping Wt.
VIG 24	24"	43
VIG 30	30"	50
VIG 36	36"	58
VIG 42	42"	65
VIG 48	48"	73
VIG 54	54"	38
VIG 60	60"	45

Insulation

Roll Insulation

- Solarguard
- Bubble White
- 3" Blanket

Tape

- Double Faced Tape
- Reinforced Patch Tape
- Bubble Insulation Tape

Underlayment

- Titanium UDL 30
- Contractor Grade
- Radiant Barrier

Alabama Steel Supply, Inc.

A Century of Evolving Steel Related Businesses

334.834.1505 phone | 334.834.7777 fax
www.alabamasteel.com

Roll/Tape/ Underlayment

Insulation



Roll Insulation

ID	Description	Roll Size
INSGW6	Solarguard	6' x 102'
INB	Bubble White	6' x 125'
IN36VR	3" Blanket	6' x 103'



Insulation Tape

ID	Description	Width	Roll Size
TAD	Double Faced Tape	1½"	60 yds.
TAR	Reinforced Patch Tape	3"	50 yds.
TAB	Bubble Insulation Tape	3"	50 yds.



Underlayments

ID	Description	Roll Size
INTU10SQ	Titanium UDL 30	10 square
INSWSP	Contractor Grade	10 square



INRB	Radiant Barrier	5 square
------	-----------------	----------

Woven polyethylene material covered by a metalized film. This metalized film provides a reflective surface that blocks up to 94% of radiant heat, so it helps keep spaces cooler in summer and warmer in winter.

Metal Studs

Stud
Track
Hat Channel

Alabama Steel Supply, Inc.

A Century of Evolving Steel Related Businesses

334.834.1505 phone | 334.834.7777 fax
www.alabamasteel.com

Stud, Track & Hat Channel

Metal Studs

Metal Studs



ID	Description
MS25G358	3 5/8" Studs 25 ga.
MS25G358TR	3 5/8" Track 25 ga.
MS20G358	3 5/8" Studs 20 ga.
MS20G358TR	3 5/8" Track 20 ga.
MS20G6	6 Studs 20 ga.
MS20G6TR	6 Track 20 ga.
MSHC20G78	7/8" Hat Channel 20 ga. 12'

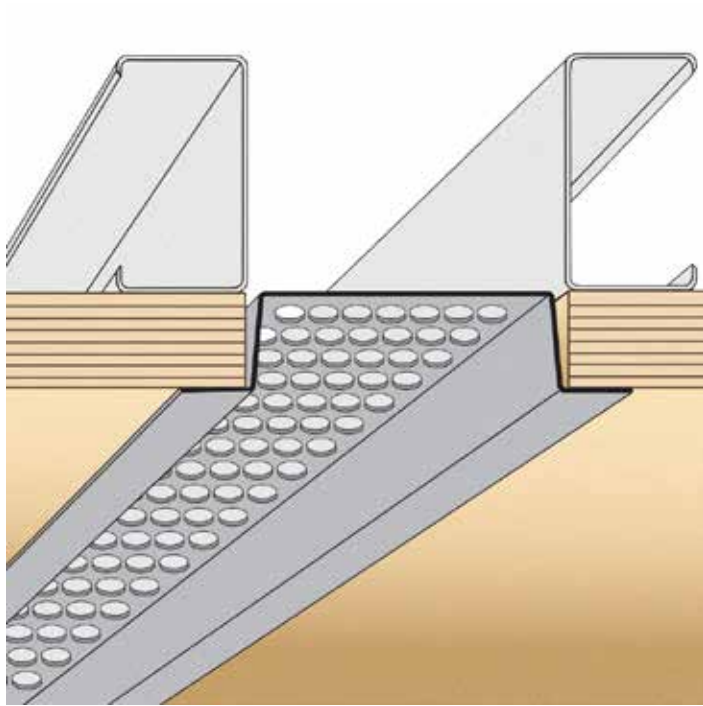
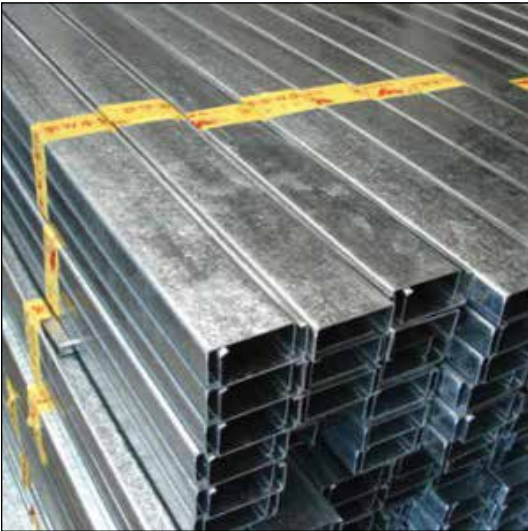

Concrete Form Deck

1½" B Deck

Alabama Steel Supply, Inc.

A Century of Evolving Steel Related Businesses

334.834.1505 phone | 334.834.7777 fax

www.alabamasteel.com

1½" B Deck

Concrete Form Deck

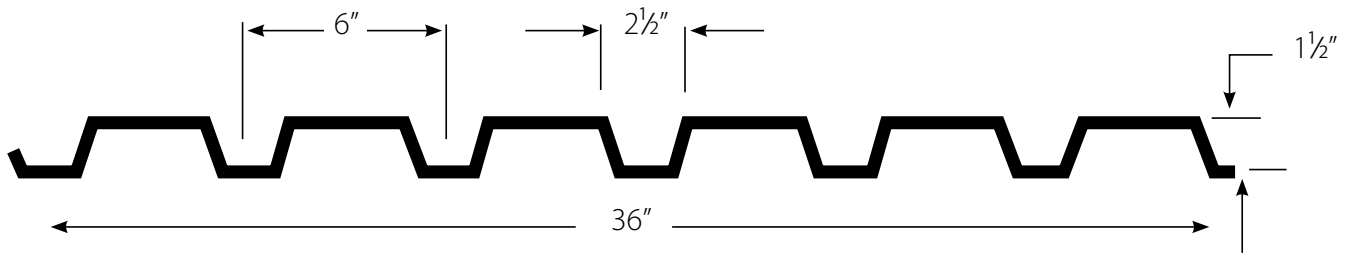
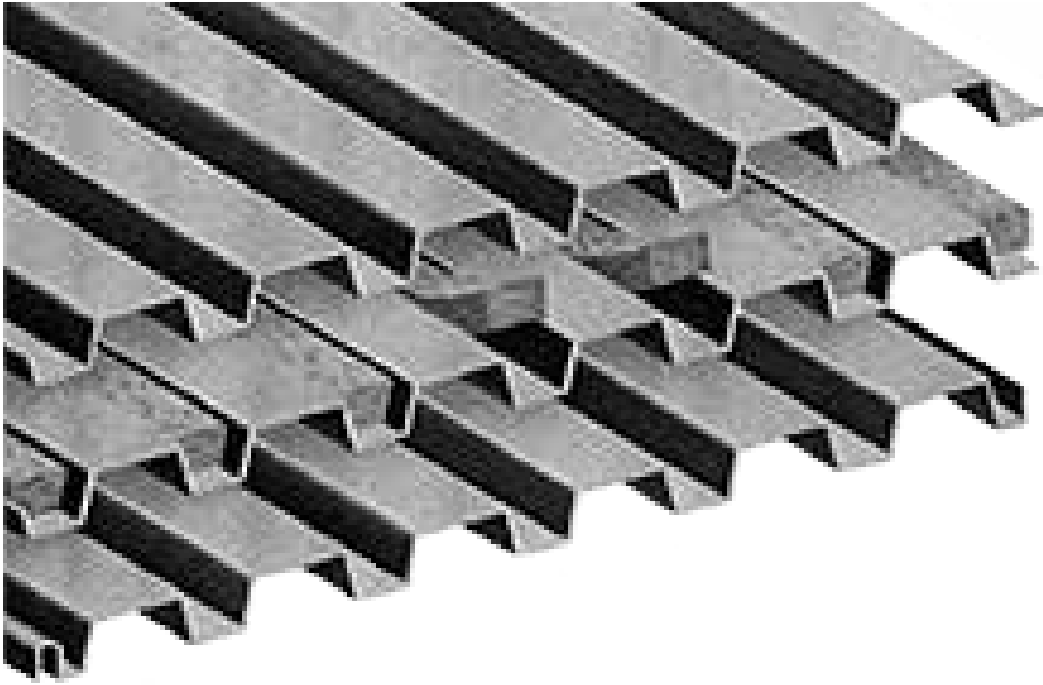

- Coverage Width = 36"
- Gauge: 22 gauge
- Coatings: Galvanized or Primer

** Other gauges and profiles available upon request*

Structurals

Angle

Channel

Rebar

Flat Bar

Round Bar

Square Bar

Square & Rectangle Tube

Sheet Steel

Pipe

Beams

Alabama Steel Supply, Inc.

A Century of Evolving Steel Related Businesses

334.834.1505 phone | 334.834.7777 fax

www.alabamasteel.com

Angle



Size	Thicknesses Available				Length
	1/8"	3/16"	1/4"	3/8"	
1" x 1"	•	•			20'
1 1/4" x 1 1/4"	•	•			20'
1 1/2" x 1 1/2"	•	•	•	•	20'
2" x 2"	•	•	•		20'
3" x 3"			•	•	20'
4" x 4"					20'

Channel



Width	Flange	Wt. Per Ft.	Length
3"	1.41	4.1	20'
4"	1.58	5.4	20'
5"	1.75	6.7	20'
6"	1.92	8.2	20'
8"	2.26	11.5	20'



Rebar

Size	Diameter	Length
#3	3/8"	20'
#4	1/2"	20'
#5	5/8"	20'
#6	3/4"	20'
#7	7/8"	20'
#8	1"	20'



Flat Bar

Size	1/8"	3/16"	1/4"	3/8"	Length
1"	.	.	.		20'
1 1/2"		.			20'
2"	20'
3"			.	.	20'
4"			.	.	20'
6"			.	.	20'
8'			.	.	20'



Round Bar Hot Rolled

Size	Length
1/4"	20'
3/8"	20'
1/2"	20'
5/8"	20'
3/4"	20'
7/8"	20'
1"	20'

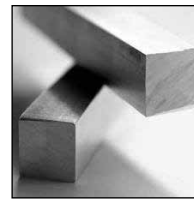

Square Bar

Size	Length
1/4"	20'
3/8"	20'
1/2"	20'
5/8"	20'
3/4"	20'
7/8"	20'
1"	20'

Square & Rectangle Tube



Sq. Size	16 ga.	14 ga.	11 ga.	3/16"	1/4"	3/8"	Lengths
1/2" x 1/2"	.						Typical 20' or 24'
3/4" x 3/4"	.	.					
1" x 1"			
1 1/2" x 1 1/2"		.	.				
2" x 2"		
3" x 3"			
4" x 4"			
6" x 6"				.	.	.	
Rec. Size							
2" x 1"	.	.					
3" x 2"		.	.	.			

Sheet Steel



Thickness	Size
16 ga.	4' x 8'
1/8"	4' x 8'
3/16"	4' x 8'
1/4"	4' x 8'

Thickness	Size
3/8"	4' x 8'
1/2"	4' x 8'
5/8"	4' x 8'

*Inquire about other available sizes

Pipe



Size	Thickness (SCH 40)	Lengths
3/4"	.113	Typical 21'
1"	.133	
1 1/4"	.140	
1 1/2"	.145	
2"	.154	
3"	.216	
4"	.237	
5"	.258	
6"	.280	
8"	.322	

* Surplus and used pipe available through 60" diameter

Beams



Size	Flange Width	Wt. Per Ft.	Lengths
4"	2.66"	7.7	Typical 20' & 40'
4"	4.16"	13	
6"	3.94"	9	
6"	5.99"	15	
8"	3.94"	10	
8"	4"	13	
10"	3.96"	12	
10"	4"	15	

* Other sizes available upon request

Expanded Metal

Expanded Metal
Bar Grating

Alabama Steel Supply, Inc.

A Century of Evolving Steel Related Businesses

334.834.1505 phone | 334.834.7777 fax
www.alabamasteel.com

Expanded Metal & Bar Grating

Expanded Metal

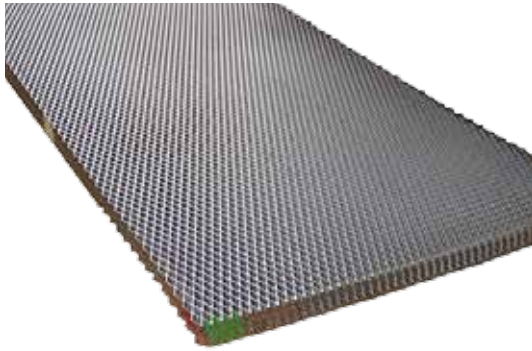

Expanded Metal

Size	Flat	Raised	Sheet Size
1/2 #16	•	•	Typical 4' x 8'
1/2 #13	•	•	
3/4 #9	•	•	
1 1/2 #9	•	•	
3 lb.		•	
4 lb.		•	

Bar Grating

Inquire about sizes in stock. Special order sizes available.



Hand Tools

Hemming Tool

Turbo Shears

Hand Snips

Hand Seamers

Hand Riveter

Hole Cutter

Alabama Steel Supply, Inc.

A Century of Evolving Steel Related Businesses

334.834.1505 phone | 334.834.7777 fax

www.alabamasteel.com

Shears, Snips, Seamers,
Riveter, Hole Cutter

Hand Tools



Hemming Tool



Turbo Shears

Snips



AV3 Aviation Snips



AV8 Aviation Snips



AV9 Aviation Snips



M2001 Snips



M2002 Snips



MD12 Snips

Hand Seamers



S2R Hand Seamer



S6R Hand Seamer

Hand Riveter



2 in 1 Hand Riveter

Hole Cutter



HC2 Hole Cutter